

Maniglioni - Maniglie - Pomoli Handles - Knobs

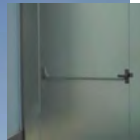

Maniglioni antipanico
Panic hardware system

pag. 0666



Maniglioni con chiusura
Handles with closing

pag. 0676

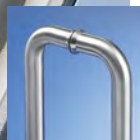

Maniglioni in acciaio AISI 304
Handles in stainless steel AISI 304

pag. 0682



Maniglioni in acciaio AISI 316L
Handles in stainless steel AISI 316L

pag. 0688



Maniglie per porte scorrevoli
Handles for sliding doors

pag. 0706



Pomoli
Knobs

pag. 0710

Handles - Knobs





Handles - Knobs

Maniglie

Maniglioni antipanico Panic hardware system



CARATTERISTICHE TECNICHE:

Certificato conformemente alla norma EN1125

Larghezza massima della porta 1300 mm

Altezza massima della porta 3400 mm (per rispettare la normativa la porta non deve superare i 2270 mm di altezza)

Peso massimo della porta 200 kg

Disponibile in finiture argento e simile inox

Possibilità di apertura dall'esterno con serratura a maniglia

TECHNICAL INFORMATIONS:

Certification according to EN1125

Maximum door width 1300 mm

Maximum door height 3400 mm (to respect the standard, maximum door height 2270 mm)

Maximum door weight 200 kg

Available finishes: silver and similar stainless steel

It is possible to open from the outside by lock with handle

KIT PER MANIGLIONE ANTIPANICO TIPOLOGIA "A"

Con chiusura centrale

Set composto da:

- chiusura ad un punto
- barra orizzontale
- piastre per fissaggio
- serratura esterna (opzionale)

PANIC HARDWARE "A" TYPOLOGY

With central closing

Fitted with:

- single-point locking
- horizontal crossbar
- fixing plates
- external lock (optional)

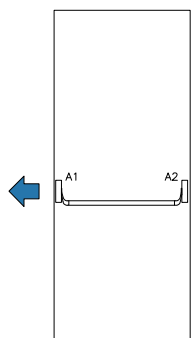

Box: 01 set

Codice / Code	Serratura esterna / External lock	Finiture / Finishes
KIT A1	no	argento/silver
KIT A2	sì/yes	argento/silver
KIT A3	no	inox/similar stainless steel
KIT A4	sì/yes	inox/similar stainless steel

Lavorazione sul vetro
Processing on the glass

A1

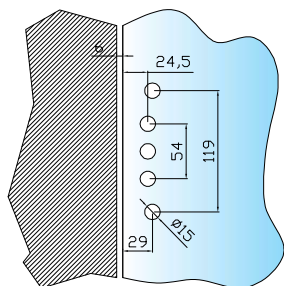

A2

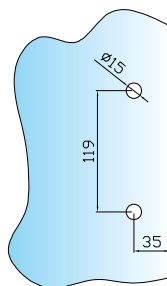

Maniglioni antipanico

Panic hardware system



KIT PER MANIGLIONE ANTIPANICO TIPOLOGIA "B"

Con chiusura centrale su vetro fisso laterale

Set composto da:

- chiusura ad un punto
- barra orizzontale
- piastre per fissaggio
- piastra per incontro a vetro
- serratura esterna (opzionale)

PANIC HARDWARE "B" TYPOLOGY

With central closing on fixed glass

Set fitted with:

- single-point locking
- horizontal crossbar
- fixing plates
- plate for glass lock keeper
- external lock (optional)

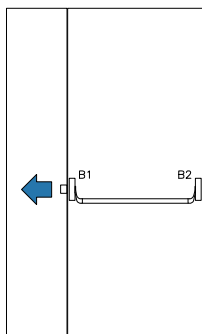

Box: 01 set

Codice/Code	Serratura esterna/External lock	Finiture/Finishes
KIT B1	no	argento/silver
KIT B2	sì/yes	argento/silver
KIT B3	no	inox/similar stainless steel
KIT B4	sì/yes	inox/similar stainless steel

Lavorazione sul vetro
Processing on the glass

B1

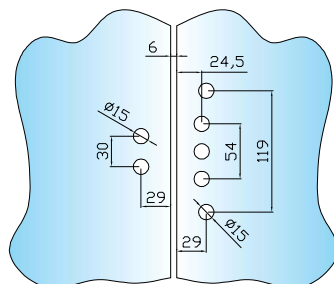

B2

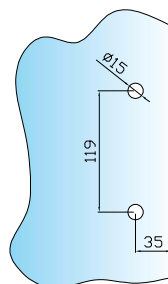

KIT PER MANIGLIONE ANTIPANICO TIPOLOGIA "C"

Con chiusura alta e bassa

Set composto da:

- chiusura a due punti
- barra orizzontale
- scrocchi alto e basso
- aste verticali
- piastre per fissaggio
- piastre per scrocchi
- sottopiastra per aste
- serratura esterna (opzionale)

PANIC HARDWARE "C" TYPOLOGY

With top and bottom closing

Fitted with:

- 2-point locking
- horizontal crossbar
- top and bottom latches
- vertical rods
- fixing plates
- plates for latches
- backplate for rods
- external lock (optional)

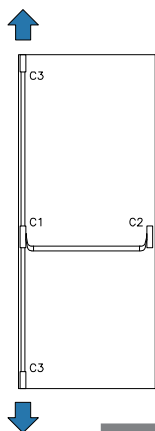

Box: 01 set

Codice / Code	Serratura esterna / External lock	Finiture / Finishes
KIT C1/2270	no	argento/silver
KIT C2/2270	sì/yes	argento/silver
KIT C3/2270	no	inox/similar stainless steel
KIT C4/2270	sì/yes	inox/similar stainless steel
KIT C1/3400	no	argento/silver
KIT C2/3400	sì/yes	argento/silver
KIT C3/3400	no	inox/similar stainless steel
KIT C4/3400	sì/yes	inox/similar stainless steel

Lavorazione sul vetro
Processing on the glass

C1

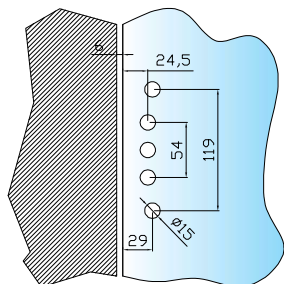

C2

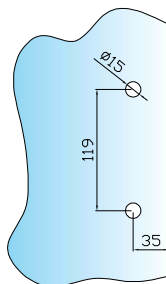

C3

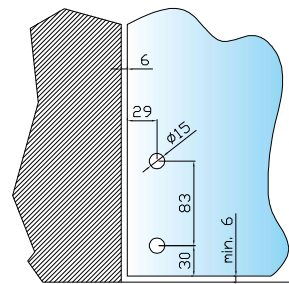

Maniglioni antipanico

Panic hardware system

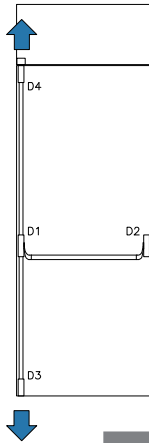

Box: 01 set

KIT PER MANIGLIONE ANTIPANICO TIPOLOGIA "D"

Con chiusura alta su sopraluce e bassa

Set composto da:

- chiusura a due punti
- barra orizzontale
- scrochi alto e basso
- aste verticali
- piastre per fissaggio
- piastre per scrochi
- sottopiastra per aste
- piastra per incontro a vetro
- serratura esterna (opzionale)

PANIC HARDWARE "D" TYPOLOGY

With top closing on transom and bottom closing

Fitted with:

- 2- point locking
- horizontal crossbar
- top and bottom latches
- vertical rods
- fixing plates
- plate for latches
- backplate for rods
- plate for glass lock keeper
- external lock (optional)

Codice/ Code	Serratura esterna/ External lock	Finiture/ Finishes
KIT D1/2270	no	argento/silver
KIT D2/2270	sì/yes	argento/silver
KIT D3/2270	no	inox/similar stainless steel
KIT D4/2270	sì/yes	inox/similar stainless steel
KIT D1/3400	no	argento/silver
KIT D2/3400	sì/yes	argento/silver
KIT D3/3400	no	inox/similar stainless steel
KIT D4/3400	sì/yes	inox/similar stainless steel

Lavorazione sul vetro
Processing on the glass

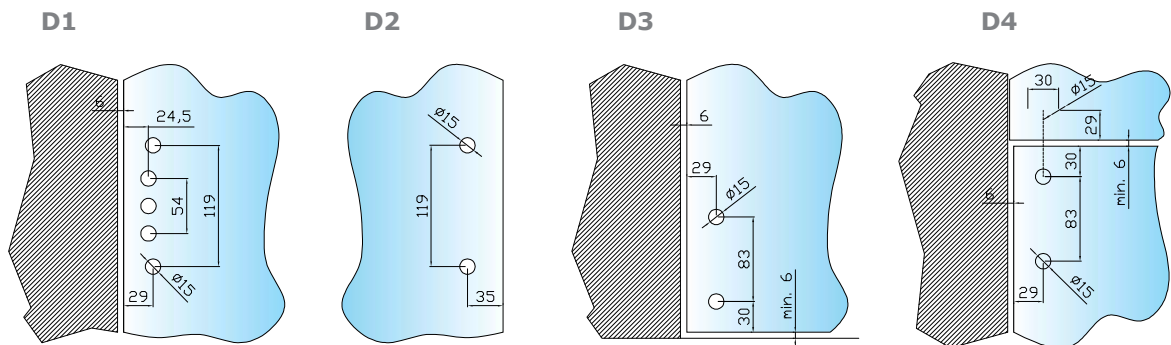

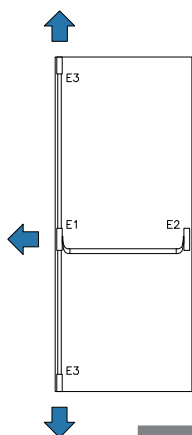

Box: 01 set

KIT PER MANIGLIONE ANTIPANICO TIPOLOGIA "E"

Con chiusura centrale, alta e bassa

Set composto da:

- chiusura ad un punto
- barra orizzontale
- scrocchi alto e basso
- aste verticali
- piastre per fissaggio
- piastre per scrocchi
- sottopiastra per aste
- serratura esterna (opzionale)

PANIC HARDWARE "E" TYPOLOGY

With central, top and bottom closing

Fitted with:

- single-point locking
- horizontal crossbar
- top and bottom latches
- vertical rods
- fixing plates
- plates for latches
- backplate for rods
- external lock (optional)

Code/Code	Serratura esterna/External lock	Finiture/Finishes
KIT E1/2270	no	argento/silver
KIT E2/2270	sì/yes	argento/silver
KIT E3/2270	no	inox/similar stainless steel
KIT E4/2270	sì/yes	inox/similar stainless steel
KIT E1/3400	no	argento/silver
KIT E2/3400	sì/yes	argento/silver
KIT E3/3400	no	inox/similar stainless steel
KIT E4/3400	sì/yes	inox/similar stainless steel

Lavorazione sul vetro
Processing on the glass

E1

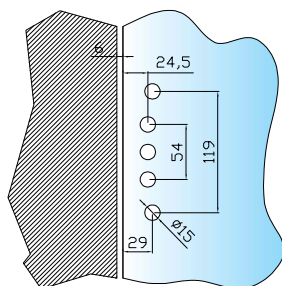

E2

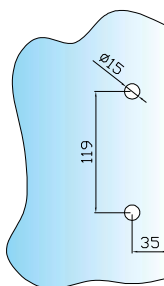

E3

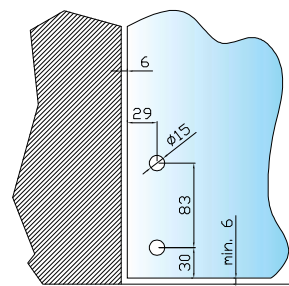

Maniglioni antipanico

Panic hardware system

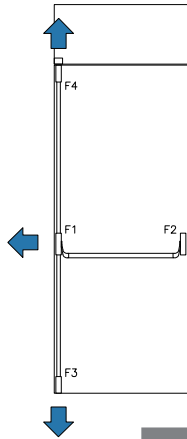

Box: 01 set

KIT PER MANIGLIONE ANTIPANICO TIPOLOGIA "F"

Con chiusura centrale, alta su sopra-luce e bassa

Set composto da:

- chiusura ad un punto
- barra orizzontale
- scrocci alto e basso
- aste verticali
- piastre per fissaggio
- piastre per scrocci
- sottopiastra per aste
- piastra per incontro a vetro
- serratura esterna (opzionale)

PANIC HARDWARE "F" TYPOLOGY

With central closing, top closing on transom and bottom closing

Fitted with:

- single-point locking
- horizontal crossbar
- top and bottom latches
- vertical rods
- fixing plates
- plates for latches
- backplate for rods
- plate for glass lock keeper
- external lock (optional)

Codice/Code	Serratura esterna/External lock	Finiture/Finishes
KIT F1/2270	no	argento/silver
KIT F2/2270	sì/yes	argento/silver
KIT F3/2270	no	inox/similar stainless steel
KIT F4/2270	sì/yes	inox/similar stainless steel
KIT F1/3400	no	argento/silver
KIT F2/3400	sì/yes	argento/silver
KIT F3/3400	no	inox/similar stainless steel
KIT F4/3400	sì/yes	inox/similar stainless steel

Lavorazione sul vetro
Processing on the glass

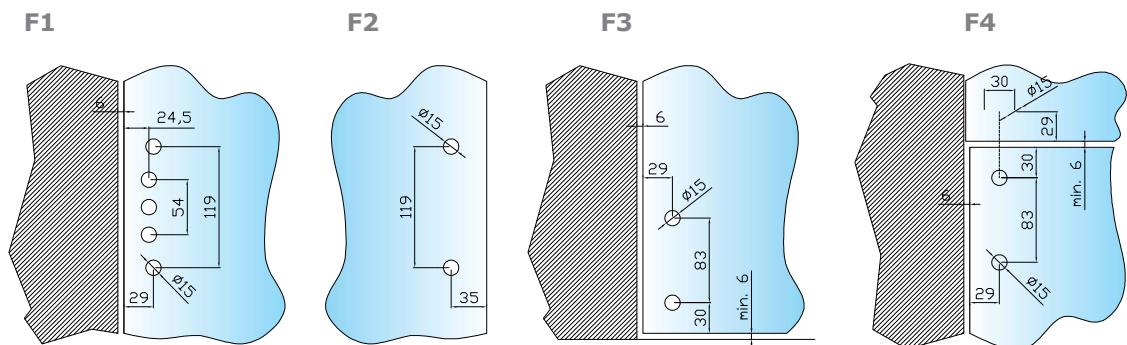

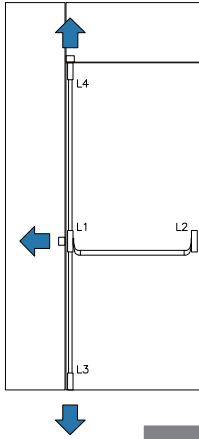

Box: 01 set

KIT PER MANIGLIONE ANTIPANICO TIPOLOGIA "L"

Con chiusura centrale su vetro fisso laterale, alta su soprauce e bassa

Set composto da:

- chiusura ad un punto
- barra orizzontale
- scrocchi alto e basso
- aste verticali
- piastre per fissaggio
- piastre per scrocchi
- sottopiastra per aste
- piastre per incontri a vetro
- serratura esterna (opzionale)

PANIC HARDWARE "L" TYPOLOGY

With central closing on lateral fixed glass, top closing on transom and bottom closing

Fitted with:

- single-point locking
- horizontal crossbar
- top and bottom latches
- vertical rods
- fixing plates
- plates for latches
- backplate for rods
- plates for glass lock keepers
- external lock (optional)

Codice/Code	Serratura esterna/External lock	Finiture/Finishes
KIT L1/2270	no	argento/silver
KIT L2/2270	sì/yes	argento/silver
KIT L3/2270	no	inox/similar stainless steel
KIT L4/2270	sì/yes	inox/similar stainless steel
KIT L1/3400	no	argento/silver
KIT L2/3400	sì/yes	argento/silver
KIT L3/3400	no	inox/similar stainless steel
KIT L4/3400	sì/yes	inox/similar stainless steel

Lavorazione sul vetro
Processing on the glass

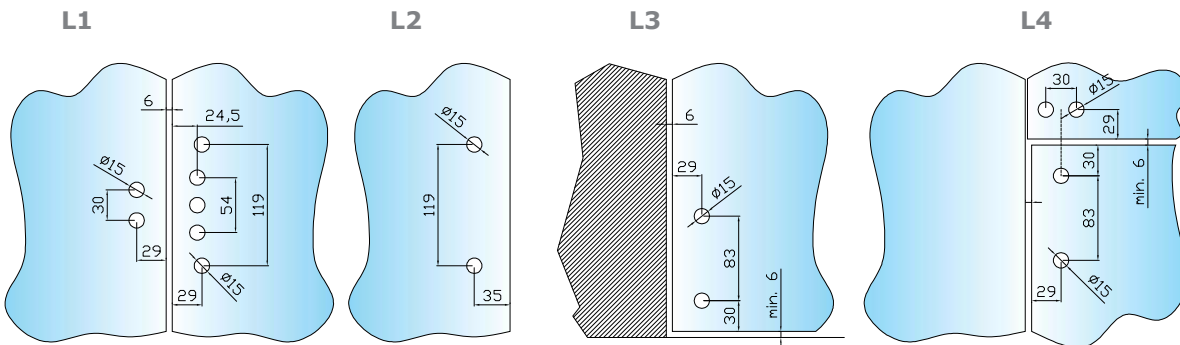

Maniglioni antipanico

Panic hardware system

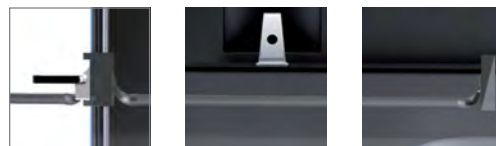

KIT PER MANIGLIONE ANTIPANICO TIPOLOGIA "I"

Porta "A" con chiusura centrale su porta "B"

Porta "B" con chiusura alta e bassa

Set composto da:

- chiusura ad un punto
- chiusura a due punti
- barre orizzontali
- scrochi alto e basso
- aste verticali
- piastre per fissaggio
- piastre per scrochi
- sottopiastra per aste
- piastra per incontro a vetro
- serratura esterna (opzionale)

PANIC HARDWARE "I" TYPOLOGY

"A" leaf with central closing on "B" leaf

"B" leaf with top and bottom closing

Fitted with:

- single-point closing
- 2-point closing
- horizontal crossbars
- top and bottom latches
- vertical rods
- fixing plates
- plates for latches
- backplate for rods
- plate for glass lock keeper
- external lock (optional)

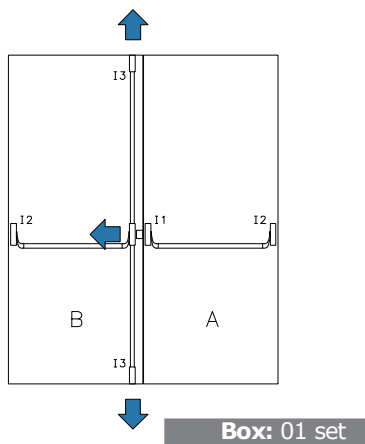

Codice/Code	Serratura esterna/External lock	Finiture/Finishes
KIT I1/2270	no	argento/silver
KIT I2/2270	sì/yes	argento/silver
KIT I3/2270	no	inox/similar stainless steel
KIT I4/2270	sì/yes	inox/similar stainless steel
KIT I1/3400	no	argento/silver
KIT I2/3400	sì/yes	argento/silver
KIT I3/3400	no	inox/similar stainless steel
KIT I4/3400	sì/yes	inox/similar stainless steel

Lavorazione sul vetro
Processing on the glass

I1

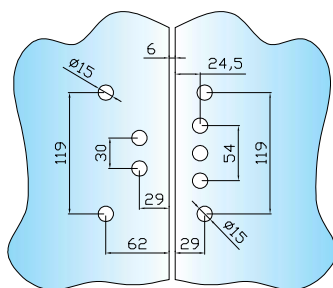

I2

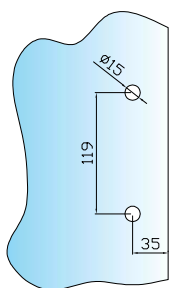

I3

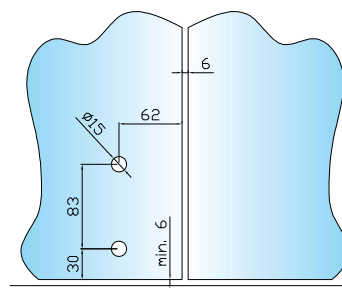

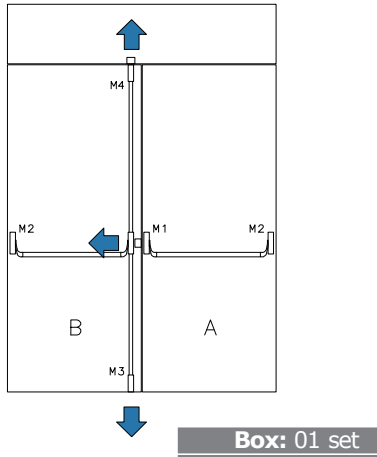

KIT PER MANIGLIONE ANTIPANICO TIPOLOGIA "M"

Porta "A" con chiusura centrale su porta "B"
 Porta "B" con chiusura alta su sopra-luce e bassa

Set composto da:

- chiusura ad un punto
- chiusura a due punti
- barre orizzontali
- scrocchi alto e basso
- aste verticali
- piastre per fissaggio
- piastre per scrocchi
- sottoplastra per aste
- piastre per incontri a vetro
- serratura esterna (opzionale)

PANIC HARDWARE "M" TYPOLOGY

"A" leaf with central closing on "B" leaf

"B" leaf with top closing on transom and bottom closing

Fitted with:

- single-point closing
- 2-point closing
- horizontal crossbars
- top and bottom latches
- vertical rods
- fixing plates
- plates for latches
- backplate for rods
- plates for glass lock keepers
- external lock (optional)

Codice/Code	Serratura esterna/External lock	Finiture/Finishes
KIT M1/2270	no	argento/silver
KIT M2/2270	si/yes	argento/silver
KIT M3/2270	no	inox/similar stainless steel
KIT M4/2270	si/yes	inox/similar stainless steel
KIT M1/3400	no	argento/silver
KIT M2/3400	si/yes	argento/silver
KIT M3/3400	no	inox/similar stainless steel
KIT M4/3400	si/yes	inox/similar stainless steel

Lavorazione sul vetro
 Processing on the glass

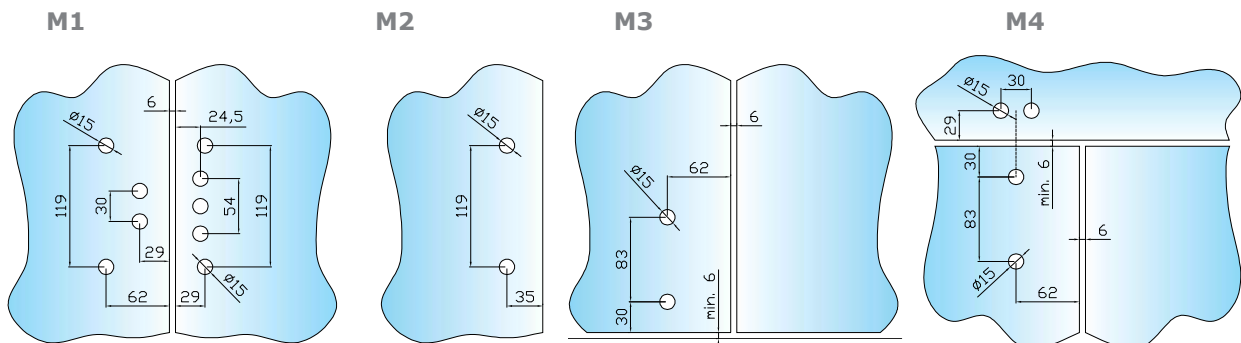

Maniglioni con chiusura

Handles with closing



Box: 01 cp/pair

MANIGLIONI QUADRI CON CHIUSURA

Sezione 25x25 mm
Acciaio AISI 316L
Chiusura da un solo lato tramite chiave
Completo di pozzetto con parapolvere
Escursione del catenaccio 20 mm circa

SQUARED HANDLES WITH CLOSING

Section 25x25 mm
Stainless steel AISI 316L
Closing on one side only through key
Fitted with dust cover floor strike
Bolt movement approximately 20 mm



Codice/Code Finiture/Finishes

E01K20711 satinato/satin
E01K20712 lucido/polished

Possibilità di fornitura in Cifratura Unica (KA) oppure in Master Key (MK).
Prezzo da definire al momento della richiesta

Available with single key or master key. Prices on request.

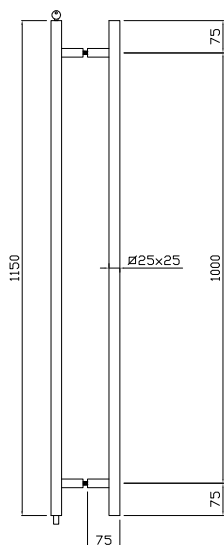

Lavorazione sul vetro
Processing on the glass

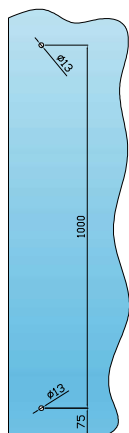



Box: 01 cp/pair

MANIGLIONI QUADRI CON CHIUSURA

Sezione 35x35 mm
Acciaio AISI 316L
Chiusura esterna tramite chiave e interna con pomolino
Completo di pozzetto con parapolvere
Escursione del catenaccio 20 mm circa

SQUARED HANDLES WITH CLOSING

Section 35x35 mm
Stainless steel AISI 316L
External closing with key and internal closing with trigger
Fitted with dust cover floor strike
Bolt movement approximately 20 mm

Codice / Code	Finiture / Finishes
E01K21511	satinato/satin
E01K21512	lucido/polished

Possibilità di fornitura in Cifratura Unica (KA) oppure in Master Key (MK).
Prezzo da definire al momento della richiesta

Available with single key or master key. Prices on request.

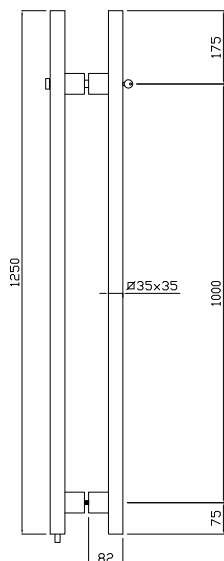

Lavorazione sul vetro
Processing on the glass

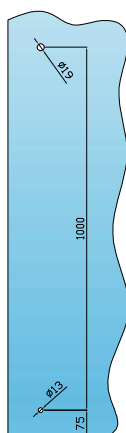

Maniglioni con chiusura

Handles with closing



Box: 01 cp/pair

MANIGLIONI CON CHIUSURA

Diametro 25 mm
 Acciaio AISI 316L
 Chiusura da un solo lato tramite chiave
 Completo di pozzetto con parapolvere
 Escursione del catenaccio 20 mm circa

HANDLES WITH CLOSING

Diameter 25 mm
 Stainless steel AISI 316L
 Closing on one side only through key
 Fitted with dust cover floor strike
 Bolt movement approximately 20 mm

Codice/Code	Finiture/Finishes
E01K01011	satinato/satin
E01K01012	lucido/polished

Possibilità di fornitura in Cifratura Unica (KA) oppure in Master Key (MK).
 Prezzo da definire al momento della richiesta

Available with single key or master key. Prices on request.

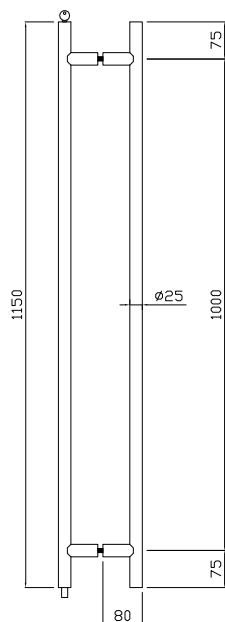

Lavorazione sul vetro
 Processing on the glass

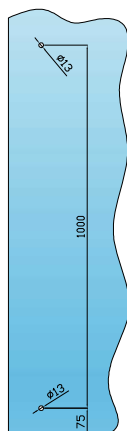



MANIGLIONI CON CHIUSURA

Diametro 35 mm
 Acciaio AISI 316L
 Chiusura esterna tramite chiave e interna con pomolino
 Completo di pozzetto con parapolvere
 Escursione del catenaccio 20 mm circa

HANDLES WITH CLOSING

Diameter 35 mm
 Stainless steel AISI 316L
 External closing with key and internal closing with trigger
 Fitted with dust cover floor strike
 Bolt movement approximately 20 mm

Codice / Code	Finiture / Finishes
E01K00211	satinato/satin
E01K00212	lucido/polished

Possibilità di fornitura in Cifratura Unica (KA) oppure in Master Key (MK).
 Prezzo da definire al momento della richiesta

Available with single key or master key. Prices on request.

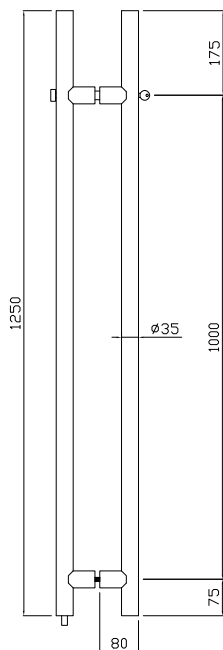

Lavorazione sul vetro
 Processing on the glass

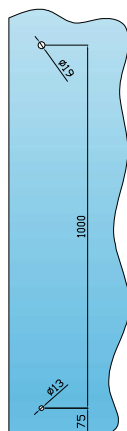

Maniglioni con chiusura

Handles with closing



Box: 01 cp/pair

MANIGLIONI CON CHIUSURA

Diametro 35 mm
Acciaio AISI 316L
Chiusura esterna tramite chiave e interna con pomolino
Catenaccio solo a pavimento
Completo di pozzetto con parapolvere
Escursione del catenaccio 20 mm circa

HANDLES WITH CLOSING

Diameter 35 mm
Stainless steel AISI 316L
External closing with key and internal closing with trigger
Floor bolt only
Fitted with dust cover floor strike
Bolt movement approximately 20 mm

Codice/Code Finiture/Finishes

E01K00411 satinato/satin
E01K00412 lucido/polished

Possibilità di fornitura in Cifratura Unica (KA) oppure in Master Key (MK).
Prezzo da definire al momento della richiesta

Available with single key or master key. Prices on request.

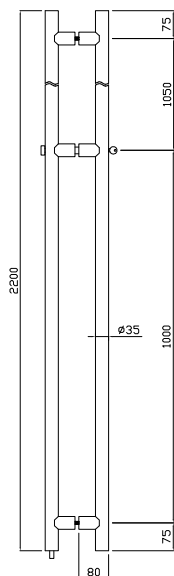

Lavorazione sul vetro
Processing on the glass

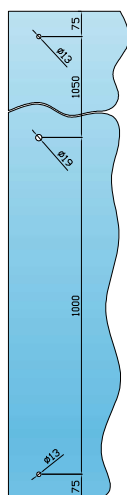



Box: 01 cp/pair

MANIGLIONI CON CHIUSURA

Diametro 35 mm
Acciaio AISI 316L
Chiusura esterna tramite chiave e interna con pomolino
Catenaccio a pavimento e a soffitto
Completo di pozzetto con parapolvere
Escursione dei catenacci 20 mm circa

HANDLES WITH CLOSING

Diameter 35 mm
Stainless steel AISI 316L
External closing with key and internal closing with trigger
Floor and ceiling bolt
Fitted with dust cover floor strike
Bolt movement approximately 20 mm

Codice/Code	Finiture/Finishes
E01K00611	satinato/satin
E01K00612	lucido/polished

Possibilità di fornitura in Cifratura Unica (KA) oppure in Master Key (MK).
Prezzo da definire al momento della richiesta

Available with single key or master key. Prices on request.

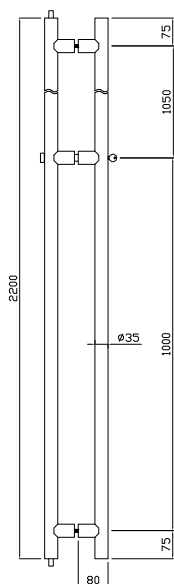

Lavorazione sul vetro
Processing on the glass

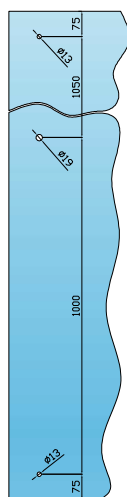

Maniglioni in acciaio AISI 304

Handles in stainless steel AISI 304



MANIGLIONI A "T"

Acciaio Aisi 304

"T" HANDLES
Stainless steel Aisi 304

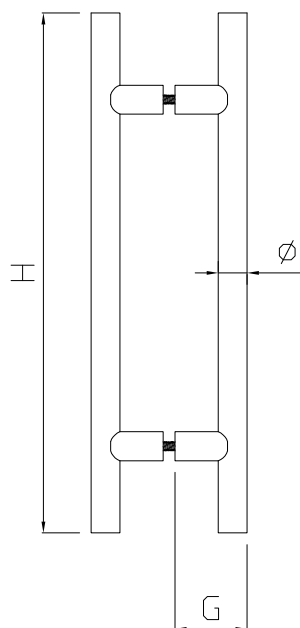

Lavorazione sul vetro
Processing on the glass

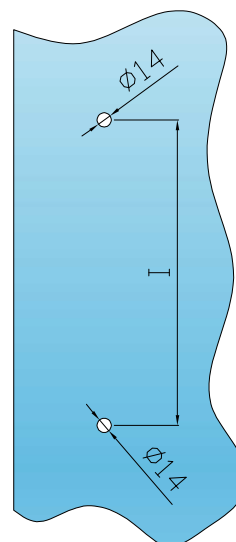

Codice/Code	Ø mm	H mm	I mm	G mm	Finitura/Finishes
E01L00091	20	450	300	58,5	satinato/satin
E01L00092	20	450	300	58,5	lucido/polished
* E01L00051	25	300	200	62,5	satinato/satin
* E01L00052	25	300	200	62,5	lucido/polished
* E01L00053	25	450	300	62,5	satinato/satin
* E01L00054	25	450	300	62,5	lucido/polished
* E01L00065	25	600	450	62,5	satinato/satin
* E01L00066	25	600	450	62,5	lucido/polished
* E01L00061	25	850	650	62,5	satinato/satin
* E01L00062	25	850	650	62,5	lucido/polished
* E01L00071	25	1200	1040	62,5	satinato/satin
* E01L00072	25	1200	1040	62,5	lucido/polished
E01L00081	20	300	200	58,5	satinato/satin
E01L00082	20	300	200	58,5	lucido/polished

* completi di anello in acciaio di appoggio su vetro
* fitted with stainless steel supporting ring



MANIGLIONI A "T"
Acciaio Aisi 304

"T" HANDLES
Stainless steel Aisi 304

Lavorazione sul vetro
Processing on the glass

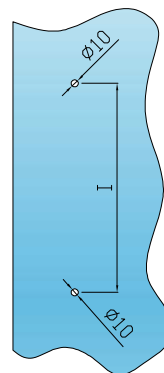
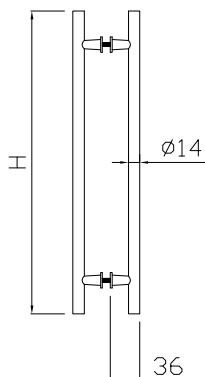

Codice/Code	H mm	I mm	Finitura/Finishes
E01L00211	370	288	satinato/satin
E01L00212	370	288	lucido/polished
E01L11016	240	160	satinato/satin
E01L21016	240	160	lucido/polished



MANIGLIONI A "T" QUADRI
Acciaio Aisi 304

SQUARED "T" HANDLES
Stainless steel Aisi 304

Lavorazione sul vetro
Processing on the glass

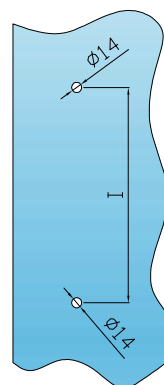
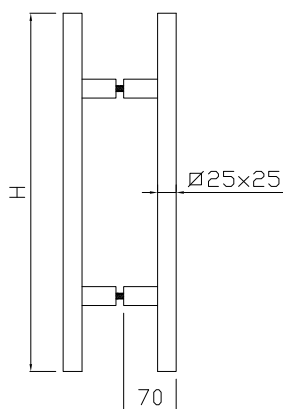

Codice/Code	H mm	I mm	Finitura/Finishes
E01Q25111	475	275	satinato/satin
E01Q25112	475	275	lucido/polished
E01Q25121	600	425	satinato/satin
E01Q25122	600	425	lucido/polished

Maniglioni in acciaio AISI 304

Handles in stainless steel AISI 304



MANIGLIONI A "M"

Acciaio Aisi 304

"M" HANDLES
Stainless steel Aisi 304

Lavorazione sul vetro
Processing on the glass

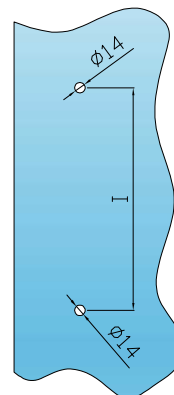
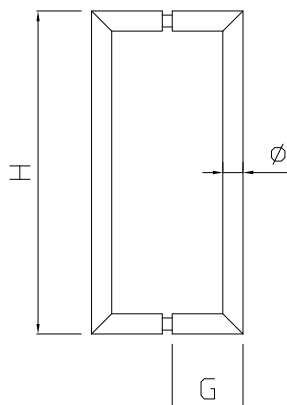

Codice/Code	Ø mm	H mm	I mm	G mm	Finitura/Finishes
E01F25142	25	450	425	72	satinato/satin
E01F25242	25	450	425	72	lucido/polished
E01F25157	25	600	575	72	satinato/satin
E01F25257	25	600	575	72	lucido/polished



MANIGLIONI QUADRI

Acciaio Aisi 304

SQUARED HANDLES
Stainless steel Aisi 304

Lavorazione sul vetro
Processing on the glass

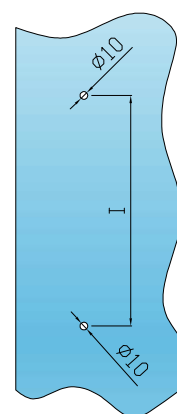
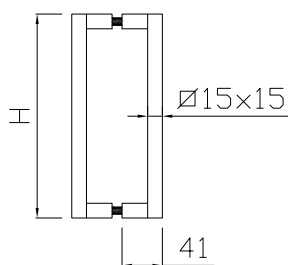

Codice/Code	H mm	I mm	Finitura/Finishes
E01Q15003	207	192	satinato/satin
E01Q15005	335	320	satinato/satin
E01Q15105	335	320	lucido/polished



Box: 01 cp/pair

MANIGLIONI A "C"

Acciaio Aisi 304

"C" HANDLES
Stainless steel Aisi 304

Lavorazione sul vetro
Processing on the glass

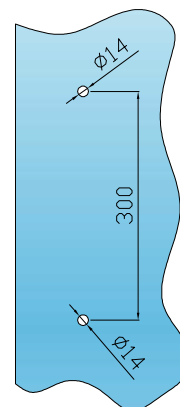
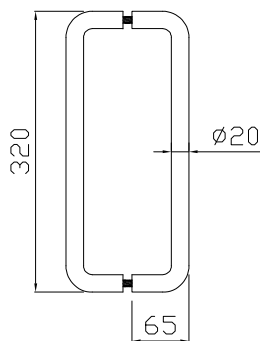

Codice/Code	Finitura/Finishes
E01B01031	satinato/satin
E01B01032	lucido/polished



Box: 01 cp/pair

MANIGLIONI A "D"

Acciaio Aisi 304

"D" HANDLES
Stainless steel Aisi 304

Lavorazione sul vetro
Processing on the glass

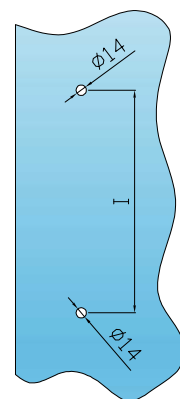
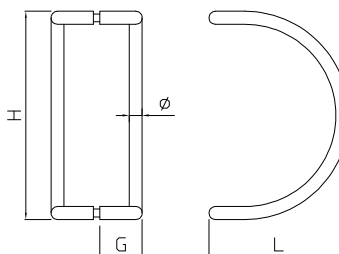

Codice/Code	Ø mm	H mm	I mm	G mm	L mm	Finiture/Finishes
E01D32130	32	337	305	89	228	satinato/satin
E01D32230	32	337	305	89	228	lucido/polished

Maniglioni in acciaio AISI 304

Handles in stainless steel AISI 304



Box: 01 cp/pair

Codice/Code	Finitura/Finishes
-------------	-------------------

E01H19145	satinato/satin
E01H19245	lucido/polished

MANIGLIONI CON PORTASCIUGAMANO

Acciaio Aisi 304

HANDLES WITH TOWEL RAIL

Stainless steel Aisi 304

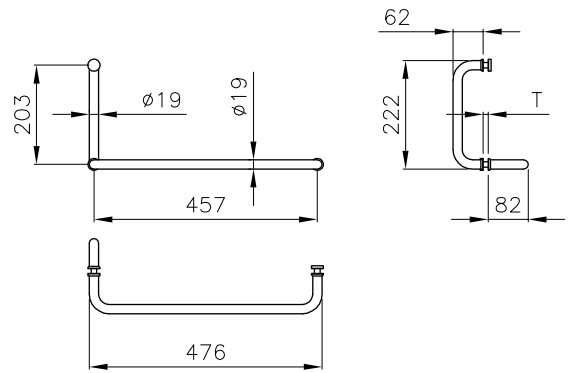

Lavorazione sul vetro
Processing on the glass

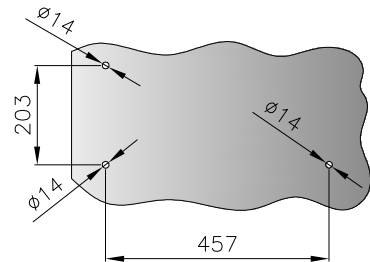



Maniglioni in acciaio AISI 316L

Handles in stainless steel AISI 316L

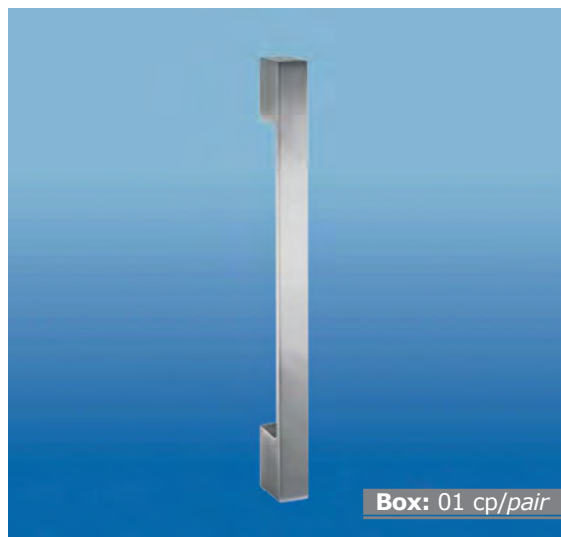
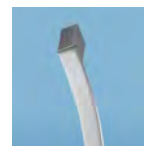

Box: 01 cp/pair

MANIGLIONI

Acciaio AISI 316L
Completati di attacco doppio a vetro

HANDLES

Stainless steel AISI 316L
Fitted with glass double fixing

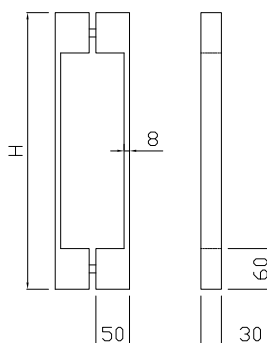

Lavorazione sul vetro
Processing on the glass

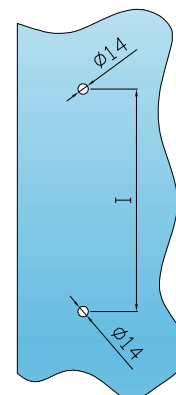

Codice/Code	H mm	I mm	Finiture/Finishes
E01G00111	410	350	satinato/satin
E01G00112	410	350	lucido/polished
E01G00121	610	550	satinato/satin
E01G00122	610	550	lucido/polished

Disponibili con dimensioni a richiesta/Dimensions on request are available



Box: 01 cp/pair

MANIGLIONI

Acciaio AISI 316L
Completati di attacco doppio a vetro

HANDLES

Stainless steel AISI 316L
Fitted with glass double fixing

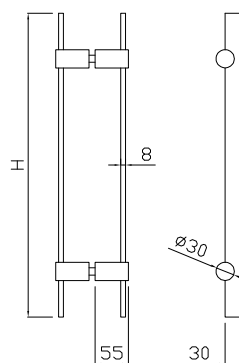

Lavorazione sul vetro
Processing on the glass

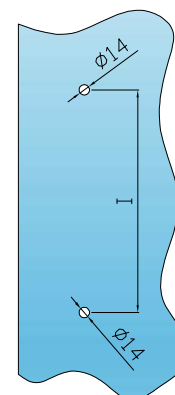

Codice/Code	H mm	I mm	Finiture/Finishes
E01G00211	500	350	satinato/satin
E01G00212	500	350	lucido/polished
E01G00221	700	550	satinato/satin
E01G00222	700	550	lucido/polished

Disponibili con dimensioni a richiesta/Dimensions on request are available



MANIGLIONI

Acciaio AISI 316L
Completi di attacco doppio a vetro

HANDLES

Stainless steel AISI 316L
Fitted with glass double fixing

Lavorazione sul vetro
Processing on the glass

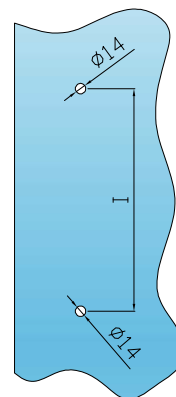
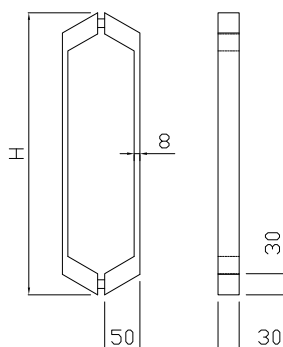

Codice/Code	H mm	I mm	Finiture/Finishes
E01G00511	400	350	satinato/satin
E01G00512	400	350	lucido/polished
E01G00521	600	550	satinato/satin
E01G00522	600	550	lucido/polished

Disponibili con dimensioni a richiesta/Dimensions on request are available



MANIGLIONI

Acciaio AISI 316L
Completi di attacco doppio a vetro

HANDLES

Stainless steel AISI 316L
Fitted with glass double fixing

Lavorazione sul vetro
Processing on the glass

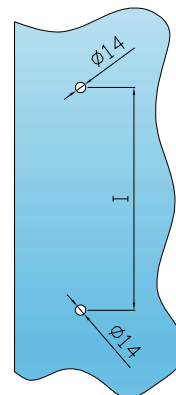
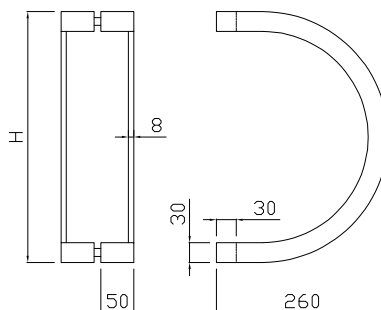

Codice/Code	H mm	I mm	Finiture/Finishes
E01G00611	380	350	satinato/satin
E01G00612	380	350	lucido/polished

Maniglioni in acciaio AISI 316L

Handles in stainless steel AISI 316L



MANIGLIONI

Acciaio AISI 316L
Completati di attacco doppio a vetro

HANDLES

Stainless steel AISI 316L
Fitted with glass double fixing

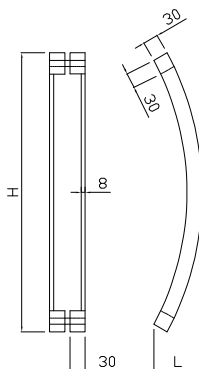

Lavorazione sul vetro
Processing on the glass

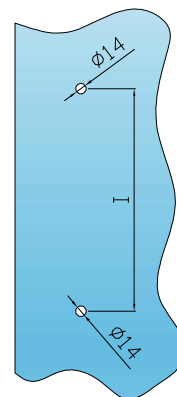

Codice/Code	H mm	I mm	L mm	Finiture/Finishes
E01G00711	550	500	95	satinato/satin
E01G00712	550	500	95	lucido/polished
E01G00721	760	700	105	satinato/satin
E01G00722	760	700	105	lucido/polished



MANIGLIONI

Acciaio AISI 316L
Completati di attacco doppio a vetro

HANDLES

Stainless steel AISI 316L
Fitted with glass double fixing

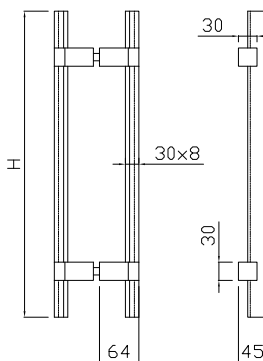

Lavorazione sul vetro
Processing on the glass

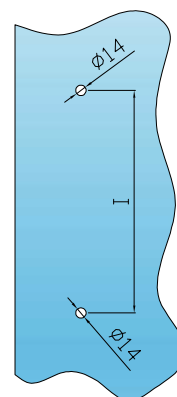

Codice/Code	H mm	I mm	Finiture/Finishes
E01G00811	500	350	satinato/satin
E01G00812	500	350	lucido/polished
E01G00821	700	550	satinato/satin
E01G00822	700	550	lucido/polished

Disponibili con dimensioni a richiesta/Dimensions on request are available



Box: 01 cp/pair

MANIGLIONI

Acciaio AISI 316L
Completi di attacco doppio a vetro

HANDLES

Stainless steel AISI 316L
Fitted with glass double fixing

Lavorazione sul vetro
Processing on the glass

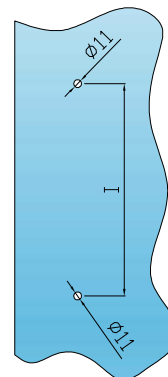
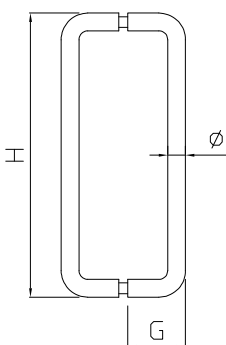

Codice/Code	Ø mm	H mm	I mm	G mm	Finiture/Finishes
E01G00911	16	141	125	60	satinato/satin
E01G00912	16	141	125	60	lucido/polished
E01G00921	16	216	200	60	satinato/satin
E01G00922	16	216	200	60	lucido/polished
E01G00931	16	266	250	60	satinato/satin
E01G00932	16	266	250	60	lucido/polished
E01G00941	16	316	300	60	satinato/satin
E01G00942	16	316	300	60	lucido/polished
E01G00951	16	366	350	60	satinato/satin
E01G00952	16	366	350	60	lucido/polished
E01G00961	16	666	650	60	satinato/satin
E01G00962	16	666	650	60	lucido/polished

Maniglioni in acciaio AISI 316L

Handles in stainless steel AISI 316L



MANIGLIONI

Acciaio AISI 316L
Completi di attacco doppio a vetro

HANDLES

Stainless steel AISI 316L
Fitted with glass double fixing

Lavorazione sul vetro
Processing on the glass

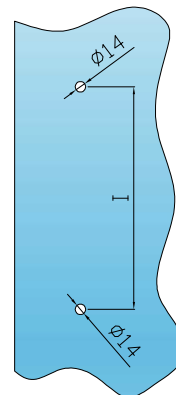
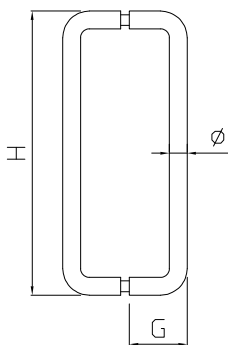

Codice/Code	Ø mm	H mm	I mm	G mm	Finiture/Finishes
E01G01011	20	220	200	65	satinato/satin
E01G01012	20	220	200	65	lucido/polished
E01G01021	20	270	250	65	satinato/satin
E01G01022	20	270	250	65	lucido/polished
E01G01031	20	320	300	65	satinato/satin
E01G01032	20	320	300	65	lucido/polished
E01G01041	20	370	350	65	satinato/satin
E01G01042	20	370	350	65	lucido/polished
E01G01111	25	225	200	70	satinato/satin
E01G01112	25	225	200	70	lucido/polished
E01G01121	25	275	250	70	satinato/satin
E01G01122	25	275	250	70	lucido/polished
E01G01131	25	325	300	70	satinato/satin
E01G01132	25	325	300	70	lucido/polished
E01G01141	25	375	350	70	satinato/satin
E01G01142	25	375	350	70	lucido/polished
E01G01211	30	260	230	85	satinato/satin
E01G01212	30	260	230	85	lucido/polished
E01G01221	30	330	300	85	satinato/satin
E01G01222	30	330	300	85	lucido/polished
E01G01231	30	350	320	85	satinato/satin
E01G01232	30	350	320	85	lucido/polished
E01G01241	30	380	350	85	satinato/satin
E01G01242	30	380	350	85	lucido/polished
E01G01251	30	680	650	85	satinato/satin
E01G01252	30	680	650	85	lucido/polished
E01G01311	35	385	350	85	satinato/satin
E01G01312	35	385	350	85	lucido/polished
E01G01321	35	685	650	85	satinato/satin
E01G01322	35	685	650	85	lucido/polished

Disponibili con dimensioni a richiesta/Dimensions on request are available



MANIGLIONI

Acciaio AISI 316L
Completi di attacco doppio a vetro

HANDLES

Stainless steel AISI 316L
Fitted with glass double fixing

Lavorazione sul vetro
Processing on the glass

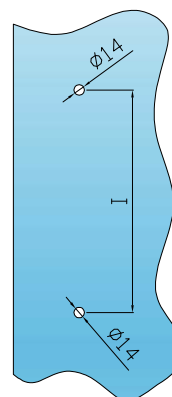
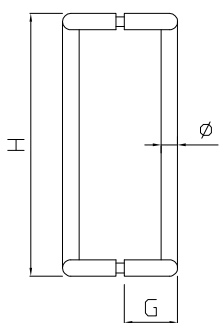

Codice/Code	Ø mm	H mm	I mm	G mm	L mm	Finiture/Finishes
E01G01411	20	220	200	65	110	satinato/satin
E01G01412	20	220	200	65	110	lucido/polished
E01G01421	20	270	250	65	110	satinato/satin
E01G01422	20	270	250	65	110	lucido/polished
E01G01431	20	320	300	65	110	satinato/satin
E01G01432	20	320	300	65	110	lucido/polished
E01G01441	20	370	350	65	110	satinato/satin
E01G01442	20	370	350	65	110	lucido/polished
E01G01511	25	225	200	70	120	satinato/satin
E01G01512	25	225	200	70	120	lucido/polished
E01G01521	25	255	250	70	120	satinato/satin
E01G01522	25	255	250	70	120	lucido/polished
E01G01531	25	325	300	70	120	satinato/satin
E01G01532	25	325	300	70	120	lucido/polished
E01G01541	25	375	350	70	120	satinato/satin
E01G01542	25	375	350	70	120	lucido/polished
E01G01611	30	260	230	85	145	satinato/satin
E01G01612	30	260	230	85	145	lucido/polished
E01G01621	30	330	300	85	145	satinato/satin
E01G01622	30	330	300	85	145	lucido/polished
E01G01631	30	350	320	85	145	satinato/satin
E01G01632	30	350	320	85	145	lucido/polished
E01G01641	30	380	350	85	145	satinato/satin
E01G01642	30	380	350	85	145	lucido/polished
E01G01651	30	680	650	85	145	satinato/satin
E01G01652	30	680	650	85	145	lucido/polished
E01G01711	35	385	350	85	155	satinato/satin
E01G01712	35	385	350	85	155	lucido/polished
E01G01721	35	685	650	85	155	satinato/satin
E01G01722	35	685	650	85	155	lucido/polished

Disponibili con dimensioni a richiesta/Dimensions on request are available

Maniglioni in acciaio AISI 316L

Handles in stainless steel AISI 316L



Box: 01 cp/pair

MANIGLIONI

Acciaio AISI 316L
Completi di attacco doppio a vetro

HANDLES

Stainless steel AISI 316L
Fitted with glass double fixing

Lavorazione sul vetro
Processing on the glass

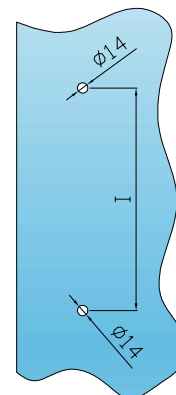
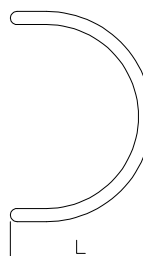
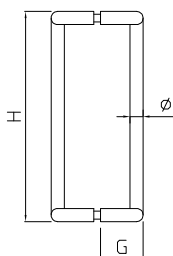

Codice/Code	Ø mm	H mm	I mm	G mm	L mm	Finiture/Finishes
E01G01811	20	270	250	65	195	satinato/satin
E01G01812	20	270	250	65	195	lucido/polished
E01G01821	20	320	300	65	215	satinato/satin
E01G01822	20	320	300	65	215	lucido/polished
E01G01911	25	175	150	70	150	satinato/satin
E01G01912	25	175	150	70	150	lucido/polished
E01G01921	25	255	250	70	225	satinato/satin
E01G01922	25	255	250	70	225	lucido/polished
E01G01931	25	325	300	70	230	satinato/satin
E01G01932	25	325	300	70	230	lucido/polished
E01G02011	30	260	230	85	240	satinato/satin
E01G02012	30	260	230	85	240	lucido/polished
E01G02021	30	280	250	85	240	satinato/satin
E01G02022	30	280	250	85	240	lucido/polished
E01G02031	30	330	300	85	260	satinato/satin
E01G02032	30	330	300	85	260	lucido/polished
E01G02041	30	380	350	85	265	satinato/satin
E01G02042	30	380	350	85	265	lucido/polished
E01G02111	35	385	350	85	300	satinato/satin
E01G02112	35	385	350	85	300	lucido/polished



Box: 01 cp/pair

MANIGLIONI

Acciaio AISI 316L
Completati di attacco doppio a vetro

HANDLES

Stainless steel AISI 316L
Fitted with glass double fixing

Lavorazione sul vetro
Processing on the glass

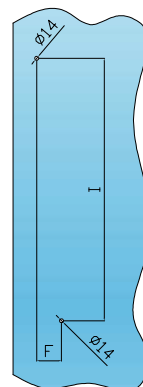
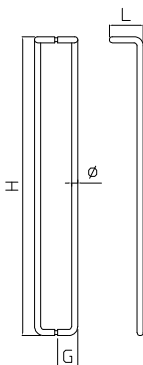

Codice/Code	Ø mm	H mm	I mm	F mm	G mm	Lmm	Finiture/Finishes
E01G02611	20	970	950	90	65	110	satinato/satin
E01G02612	20	970	950	90	65	110	lucido/polished
E01G02711	25	975	950	95	70	120	satinato/satin
E01G02712	25	975	950	95	70	120	lucido/polished
E01G02811	30	980	950	115	85	145	satinato/satin
E01G02812	30	980	950	115	85	145	lucido/polished
E01G02821	30	1230	1200	115	85	145	satinato/satin
E01G02822	30	1230	1200	115	85	145	lucido/polished
E01G02911	35	985	950	120	85	155	satinato/satin
E01G02912	35	985	950	120	85	155	lucido/polished
E01G02921	35	1235	1200	120	85	155	satinato/satin
E01G02922	35	1235	1200	120	85	155	lucido/polished

Disponibili con dimensioni a richiesta/Dimensions on request are available

Maniglioni in acciaio AISI 316L

Handles in stainless steel AISI 316L



MANIGLIONI

Acciaio AISI 316L
Completi di attacco doppio a vetro

HANDLES

Stainless steel AISI 316L
Fitted with glass double fixing

Lavorazione sul vetro
Processing on the glass

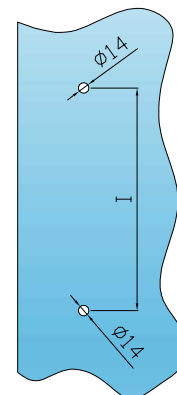
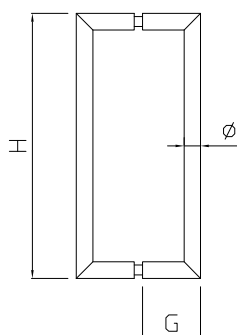

Codice/Code	Ø mm	H mm	I mm	G mm	L mm	Finiture/Finishes
E01G03011	20	320	300	65	70	satinato/satin
E01G03012	20	320	300	65	70	lucido/polished
E01G03111	25	275	250	65	60	satinato/satin
E01G03112	25	275	250	65	60	lucido/polished
E01G03121	25	525	500	65	90	satinato/satin
E01G03122	25	525	500	65	90	lucido/polished
E01G03211	30	330	300	70	70	satinato/satin
E01G03212	30	330	300	70	70	lucido/polished
E01G03221	30	630	600	70	110	satinato/satin
E01G03222	30	630	600	70	110	lucido/polished
E01G03311	35	385	350	75	80	satinato/satin
E01G03312	35	385	350	75	80	lucido/polished
E01G03321	35	735	700	75	125	satinato/satin
E01G03322	35	735	700	75	125	lucido/polished



MANIGLIONI

Acciaio AISI 316L
Completati di attacco doppio a vetro

HANDLES

Stainless steel AISI 316L
Fitted with glass double fixing

Lavorazione sul vetro
Processing on the glass

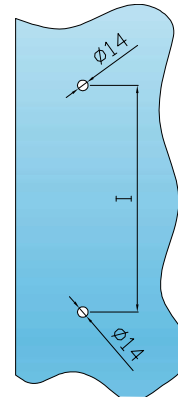
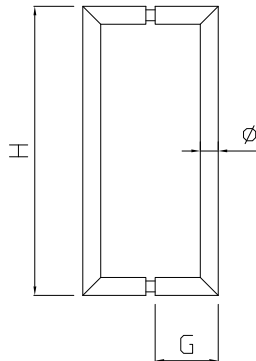

Codice/Code	Ø mm	H mm	I mm	G mm	Finiture/Finishes
E01G03411	20	220	200	60	satinato/satin
E01G03412	20	220	200	60	lucido/polished
E01G03511	25	325	300	65	satinato/satin
E01G03512	25	325	300	65	lucido/polished
E01G03611	30	380	350	70	satinato/satin
E01G03612	30	380	350	70	lucido/polished
E01G03711	35	385	350	75	satinato/satin
E01G03712	35	385	350	75	lucido/polished

Disponibili con dimensioni a richiesta/Dimensions on request are available

Maniglioni in acciaio AISI 316L

Handles in stainless steel AISI 316L



MANIGLIONI ELLITICI

Acciaio AISI 316L
Completati di attacco doppio a vetro

ELLIPTICAL HANDLES

Stainless steel AISI 316L
Fitted with glass double fixing

Lavorazione sul vetro
Processing on the glass

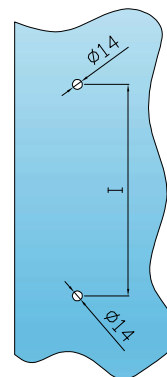
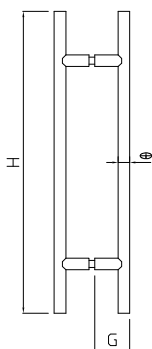

Codice/Code	Ø mm	H mm	I mm	G mm	Finiture/Finishes
E01G04511	40x20	520	350	60	satinato/satin
E01G04512	40x20	520	350	60	lucido/polished
E01G04521	40x20	720	550	60	satinato/satin
E01G04522	40x20	720	550	60	lucido/polished

Disponibili con dimensioni a richiesta/Dimensions on request are available



MANIGLIONI ELLITICI

Acciaio AISI 316L
Completati di attacco doppio a vetro

ELLIPTICAL HANDLES

Stainless steel AISI 316L
Fitted with glass double fixing

Lavorazione sul vetro
Processing on the glass

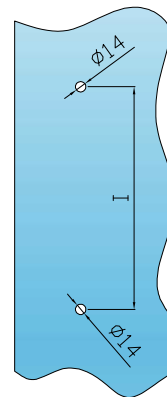
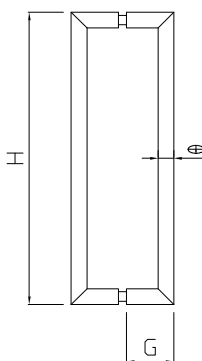

Codice/Code	Ø mm	H mm	I mm	G mm	Finiture/Finishes
E01G04611	40x20	370	350	60	satinato/satin
E01G04612	40x20	370	350	60	lucido/polished
E01G04621	40x20	670	650	60	satinato/satin
E01G04622	40x20	670	650	60	lucido/polished



Maniglie per porte scorrevoli

Handles for sliding doors



MANIGLIA PER PORTA SCORREVOLE A SCOMPARSA INTERNO MURO

In ottone
Spessore vetro 8-10 mm

HANDLE FOR IN-WALL SLIDING DOOR

In brass
Glass thickness 8-10 mm

Codice / Code	Finiture / Finishes
E07M02715	Cromo lucido / polished chrome
E07M02716	Cromo opaco / opaque chrome
E07M02720	Simil inox / similar stainless steel
E07M02713	Oro lucido / polished gold

Lavorazione sul vetro
Processing on the glass

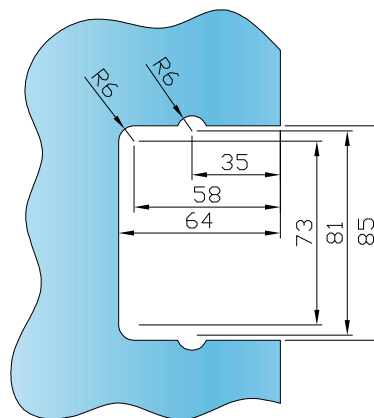
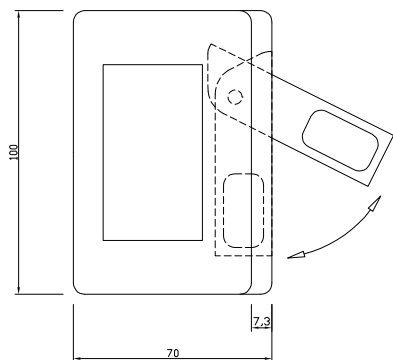



**MANIGLIA RETTANGOLARE PER PORTA SCORREVOLE
IN ACCIAIO AISI 304**

Spessore vetro 8-10-12 mm

**RECTANGULAR HANDLE FOR SLIDING DOOR
IN STAINLESS STEEL AISI 304**

Glass thickness 8-10-12 mm

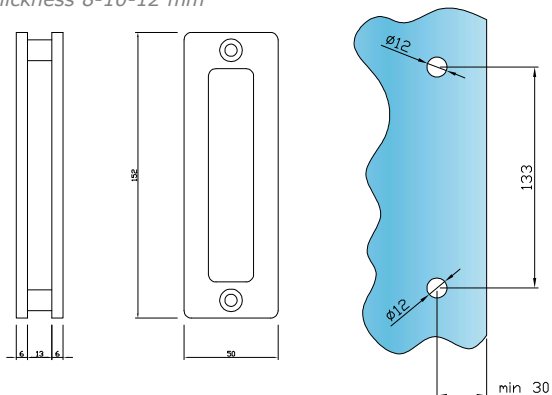

Codice/Code	Dim./Dim.	Finiture/Finishes
E07M03810	150 x 50 mm	acciaio satinato/satin stainless steel
E07M03812	150 x 50 mm	acciaio lucido/polished stainless steel



**MANIGLIA AD ELLISSE PER PORTA SCORREVOLE
IN ACCIAIO AISI 304**

Spessore vetro 8-10-12 mm

**ELLIPTICAL HANDLE FOR SLIDING DOOR
IN STAINLESS STEEL AISI 304**

Glass thickness 8-10-12 mm

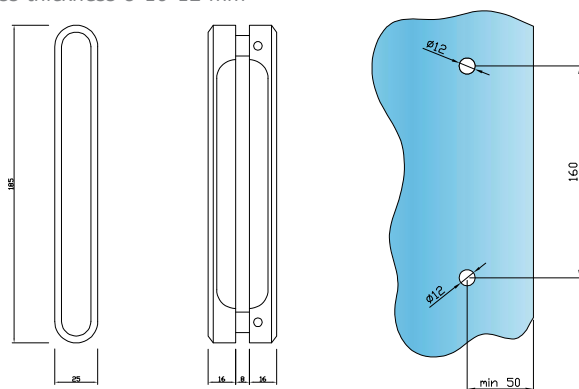

Codice/Code	Dim./Dim.	Finiture/Finishes
E07M08810	185 x 25 mm	acciaio satinato/satin stainless steel
E07M08812	185 x 25 mm	acciaio lucido/polished stainless steel

Maniglie per porte scorrevoli

Handles for sliding doors

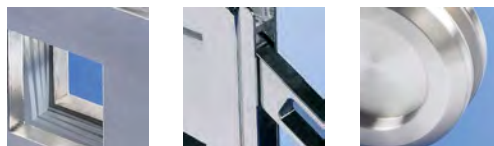

Box: 01 cp/pair

MANIGLIA QUADRATA PER PORTA SCORREVOLE IN ACCIAIO AISI 304

Spessore vetro 8-10-12 mm

SQUARED HANDLE FOR SLIDING DOOR IN STAINLESS STEEL AISI 304

Glass thickness 8-10-12 mm

Lavorazione sul vetro
Processing on the glass

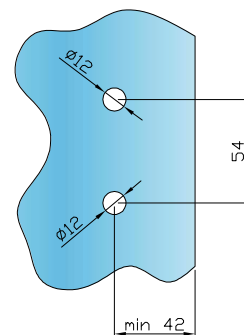
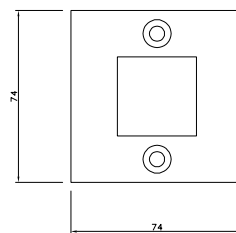
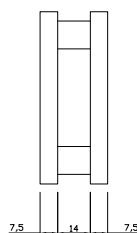

Codice/Code	Dim./Dim.	Finiture/Finishes
E07M04810	75 x 75 mm	acciaio satinato/satin stainless steel
E07M04812	75 x 75 mm	acciaio lucido/polished stainless steel



Box: 01 cp/pair

MANIGLIA QUADRATA MM 50X50 IN ACCIAIO AISI 304

Spessore vetro 8-10-12 mm

SQUARED HANDLE 50X50 MM IN STAINLESS STEEL AISI 304

Glass thickness 8-10-12 mm

Lavorazione sul vetro
Processing on the glass

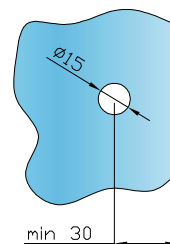
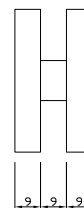
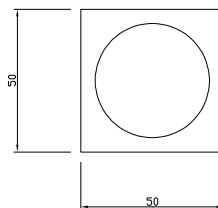

Codice/Code	Dim./Dim.	Finiture/Finishes
E07M06810	50 x 50 mm	acciaio satinato/satin stainless steel
E07M06812	50 x 50 mm	acciaio lucido/polished stainless steel

Innovate by Design



Box: 01 cp/pair

**MANIGLIA ROTONDA PER PORTA SCORREVOLE
IN ACCIAIO AISI 304**

Spessore vetro 8-10-12 mm

**ROUND HANDLE FOR SLIDING DOOR
IN STAINLESS STEEL AISI 304**

Glass thickness 8-10-12 mm

Lavorazione sul vetro
Processing on the glass

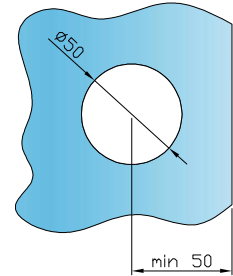
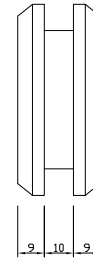
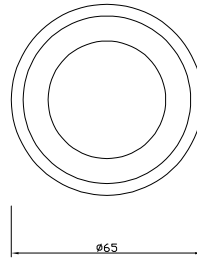

Codice/Code	Ø	Finiture/Finishes
E07M05810	65 mm	acciaio satinato/satin stainless steel
E07M05812	65 mm	acciaio lucido/polished stainless steel



Box: 01 cp/pair

**MANIGLIA ROTONDA PER PORTA SCORREVOLE
IN ACCIAIO AISI 304**

Spessore vetro 8-10-12 mm

**ROUND HANDLE FOR SLIDING DOOR
IN STAINLESS STEEL AISI 304**

Glass thickness 8-10-12 mm

Lavorazione sul vetro
Processing on the glass

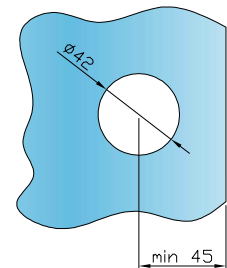
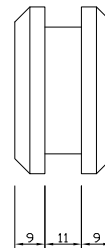
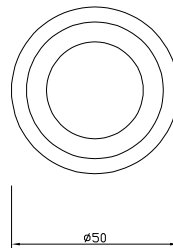

Codice/Code	Ø	Finiture/Finishes
E07M09810	50	acciaio satinato/satin stainless steel
E07M09812	50	acciaio lucido/polished stainless steel

Pomoli Knobs



POMOLI QUADRATI 30X30 MM
Ottone

SQUARED KNOBS 30X30 MM
Brass

Lavorazione sul vetro
Processing on the glass

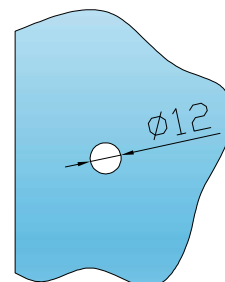

Codice/Code	Finiture/Finishes
E01M06715	cromo lucido/polished chrome
E01M06716	cromo opaco/opaque chrome
E01M06720	simile acciaio inox/similar stainless steel

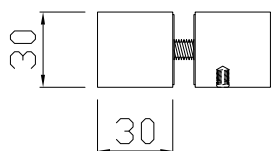

POMOLI QUADRATI 20X20 MM
Ottone

SQUARED KNOBS 20X20 MM
Brass

Lavorazione sul vetro
Processing on the glass

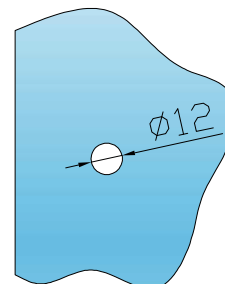

Codice/Code	Finiture/Finishes
E01M09715	cromo lucido/polished chrome
E01M09716	cromo opaco/opaque chrome
E01M09720	simile acciaio inox/similar stainless steel

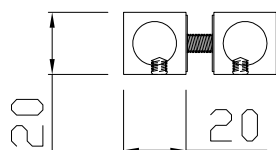



Box: 06 cp/pair

**POMOLI CILINDRICI Ø 25 MM
CON VITE DI BLOCCAGGIO**

Ottone

**CYLINDER KNOBS Ø 25 MM
WITH FIXING SCREW**

Brass

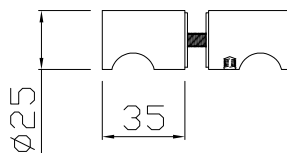

Lavorazione sul vetro
Processing on the glass

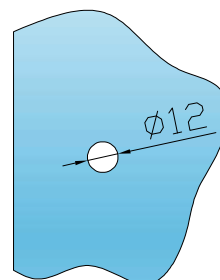

Codice/Code

Finiture/Finishes

E01M02011

cromato lucido/polished chrome

E01M01011

cromato opaco/opaque chrome

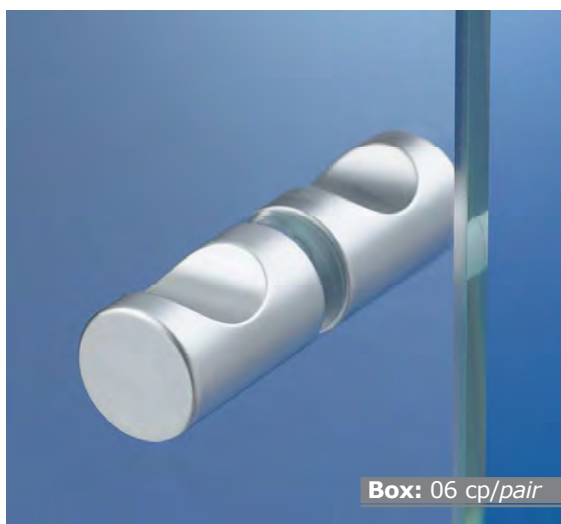

Box: 06 cp/pair

**POMOLI CILINDRICI Ø 25 MM
Ottone**

Ottone

CYLINDER KNOBS Ø 25 MM

Brass

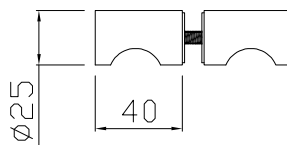

Lavorazione sul vetro
Processing on the glass

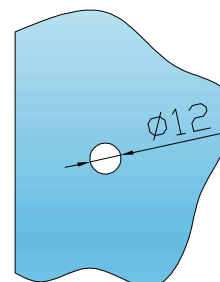

Codice/Code

Finiture/Finishes

E01M02001

cromato lucido/polished chrome

E01M01001

cromato opaco/opaque chrome

E01M04001

oro lucido/polished gold

Pomoli Knobs



Box: 12 cp/pair

POMOLI CILINDRICI Ø 14 MM

Ottone

CYLINDER KNOBS Ø 14 MM

Brass

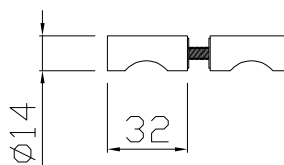

Lavorazione sul vetro
Processing on the glass

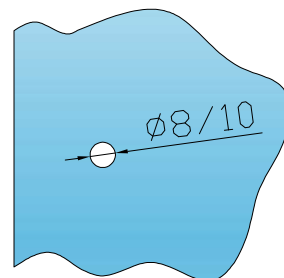

Codice/Code	Finiture/Finishes
E01M02002	cromato lucido/polished chrome
E01M01002	cromato opaco/opaque chrome



Box: 05 cp/pair

POMOLI A GOLA Ø 30 MM

Ottone

GROOVED KNOBS Ø 30 MM

Brass

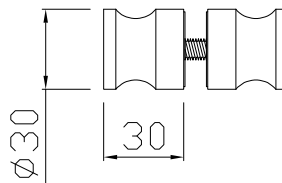

Lavorazione sul vetro
Processing on the glass

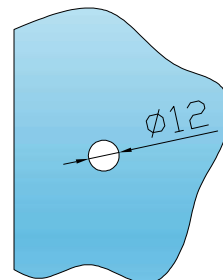

Codice/Code	Finiture/Finishes
E01M05715	cromato lucido/polished chrome
E01M05716	cromato opaco/opaque chrome
E01M05611	simile alluminio/similar aluminium
E01M05720	simil inox/similar stainless steel
E01M05713	oro lucido/polished gold



Box: 10 pz/pcs

POMOLO SINGOLO A GOLA Ø 30 MM

Ottone

SINGLE GROOVED KNOB Ø 30 MM

Brass

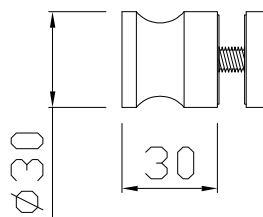

Lavorazione sul vetro
Processing on the glass

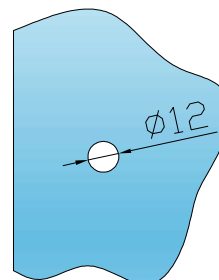

Codice/Code	Finiture/Finishes
E01M25715	cromato lucido/polished chrome
E01M25716	cromato opaco/opaque chrome
E01M25611	simile alluminio/similar aluminium
E01M25720	simil inox/similar stainless steel
E01M25713	oro lucido/polished gold



Box: 01 cp/pair

POMOLI AD ELLISSE Ø45

Alluminio

ELLIPTICAL KNOBS Ø 45

Aluminium

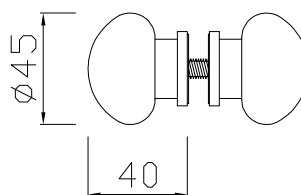

Lavorazione sul vetro
Processing on the glass

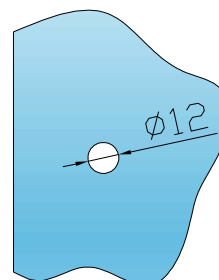

Codice/Code	Ø	Finiture/Finishes
E01M02611	45 mm	simile alluminio/similar aluminium
E01M02713	45 mm	oro lucido/polished gold
E01M02715	45 mm	cromato lucido/polished chrome
E01M02716	45 mm	cromato opaco/opaque chrome
E01M02720	45 mm	simil inox/similar stainless steel

Pomoli Knobs



Box: 01 cp/pair

POMOLI AD ELLISSE Ø60 MM Alluminio

ELLIPTICAL KNOBS Ø 60 Aluminium

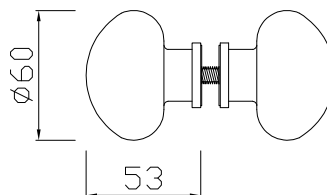

Lavorazione sul vetro
Processing on the glass

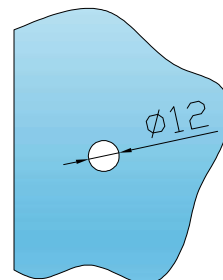

Codice/Code	Ø	Finiture/Finishes
E01M04611	60 mm	simile alluminio/similar aluminium
E01M04713	60 mm	oro lucido/polished gold
E01M04715	60 mm	cromato lucido/polished chrome
E01M04716	60 mm	cromato opaco/opaque chrome
E01M04720	60 mm	simil inox/similar stainless steel



Box: 01 cp/pair

POMOLI A SFERA Ø60 MM Alluminio

SPHERICAL KNOBS Ø 60 MM Aluminium

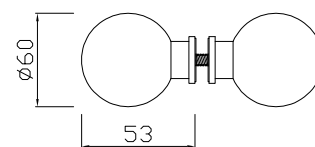

Lavorazione sul vetro
Processing on the glass

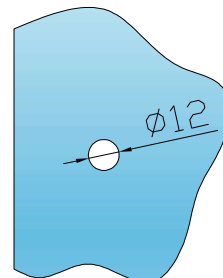

Codice/Code	Ø	Finiture/Finishes
E01M03611	60 mm	simile alluminio/similar aluminium
E01M03715	60 mm	cromato lucido/polished chrome
E01M03716	60 mm	cromato opaco/opaque chrome
E01M03720	60 mm	simil inox/similar stainless steel



Box: 01 pz/pcs

POMOLI AD INCOLLAGGIO CON TACCA
Acciaio AISI 304

UV GLUING KNOBS WITH NOTCH
Stainless steel AISI 304

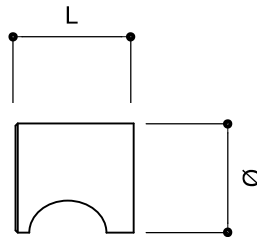

Codice/Code	Ø	L	Finiture/Finishes
N05M24001	24 mm	32 mm	satinato/satin



Box: 01 pz/pcs

POMOLI AD INCOLLAGGIO A GOLA
Acciaio AISI 304

UV GLUING GROOVED KNOBS
Stainless steel AISI 304

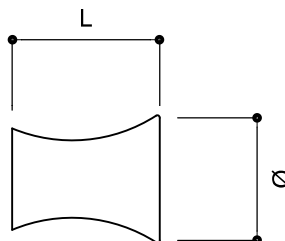

Codice/Code	Ø	L	Finiture/Finishes
N05M24002	24 mm	28 mm	satinato/satin

Pomoli Knobs

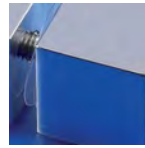

Box: 01 pz/pcs

POMOLI AD INCOLLAGGIO CILINDRICI Acciaio AISI 304

UV GLUING CYLINDER KNOBS
Stainless steel AISI 304

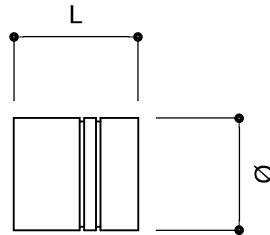

Codice/Code	Ø	L	Finiture/Finishes
N05M24003	24 mm	28 mm	satinato/satin



Box: 01 cp/pair

POMOLI IN VETRO Ø40

GLASS KNOBS Ø 40

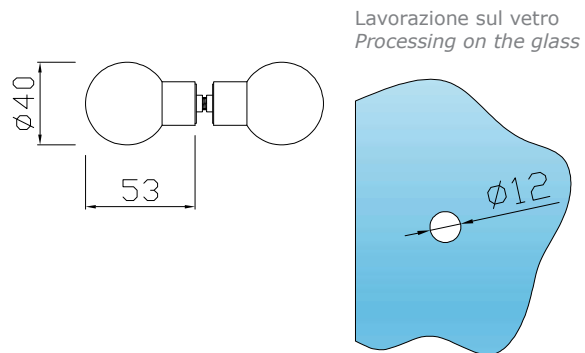

Colore vetro Glass colour	Finiture base cromo lucido Polished chrome base	Finiture base cromo satinato Satin chrome base	Finiture base oro lucido Polished gold base	Finiture base oro satinato Satin gold base
Trasparente/Transparent	Cod. E01P40201	Cod. E01P40101	Cod. E01P40401	Cod. E01P40301
Satinato bianco Satin white	Cod. E01P40206	Cod. E01P40106	Cod. E01P40406	Cod. E01P40306
Trasp. con bolle Transparent with bubbles	Cod. E01P40211	Cod. E01P40111	Cod. E01P40411	Cod. E01P40311

A richiesta/On request

Colore vetro Glass colour	Finiture base cromo lucido Polished chrome base	Finiture base cromo satinato Satin chrome base	Finiture base oro lucido Polished gold base	Finiture base oro satinato Satin gold base
Rosa/Pink	Cod. E01P40202	Cod. E01P40102	Cod. E01P40402	Cod. E01P40302
Acquamare/Acquamarine	Cod. E01P40203	Cod. E01P40103	Cod. E01P40403	Cod. E01P40303
Verde/Green	Cod. E01P40205	Cod. E01P40105	Cod. E01P40405	Cod. E01P40305
Blu/Blue	Cod. E01P40204	Cod. E01P40104	Cod. E01P40404	Cod. E01P40304
Satinato acquamare Satin aquamarine	Cod. E01P40208	Cod. E01P40108	Cod. E01P40408	Cod. E01P40308
Satinato rosa Satin pink	Cod. E01P40207	Cod. E01P40107	Cod. E01P40407	Cod. E01P40307
Satinato blu Satin blue	Cod. E01P40209	Cod. E01P40109	Cod. E01P40409	Cod. E01P40309
Satinato verde Satin green	Cod. E01P40210	Cod. E01P40110	Cod. E01P40410	Cod. E01P40310

Non adatti ad applicazioni su esterni/Not suitable for outdoor installations

Pomoli Knobs

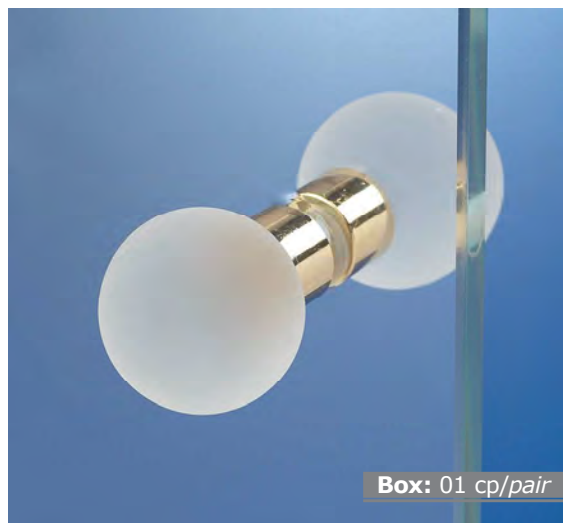

Box: 01 cp/pair

POMOLI IN VETRO Ø50

GLASS KNOBS Ø 50

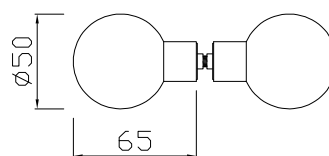

Lavorazione sul vetro
Processing on the glass

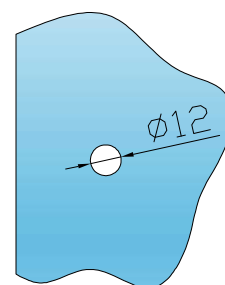

Colore vetro Glass colour	Finiture base cromo lucido Polished chrome base	Finiture base cromo satinato Satin chrome base	Finiture base oro lucido Polished gold base	Finiture base oro satinato Satin gold base
Trasparente/Transparent	Cod. E01P50201	Cod. E01P50101	Cod. E01P50401	Cod. E01P50301
Satinato bianco Satin white	Cod. E01P50206	Cod. E01P50106	Cod. E01P50406	Cod. E01P50306
Trasp. con bolle Transparent with bubbles	Cod. E01P50211	Cod. E01P50111	Cod. E01P50411	Cod. E01P50311

A richiesta/On request

Colore vetro Glass colour	Finiture base cromo lucido Polished chrome base	Finiture base cromo satinato Satin chrome base	Finiture base oro lucido Polished gold base	Finiture base oro satinato Satin gold base
Rosa/Pink	Cod. E01P50202	Cod. E01P50102	Cod. E01P50402	Cod. E01P50302
Acquamare/Acquamarine	Cod. E01P50203	Cod. E01P50103	Cod. E01P50403	Cod. E01P50303
Verde/Green	Cod. E01P50205	Cod. E01P50105	Cod. E01P50405	Cod. E01P50305
Blu/Blue	Cod. E01P50204	Cod. E01P50104	Cod. E01P50404	Cod. E01P50304
Satinato acquamare Satin aquamarine	Cod. E01P50208	Cod. E01P50108	Cod. E01P50408	Cod. E01P50308
Satinato rosa Satin pink	Cod. E01P50207	Cod. E01P50107	Cod. E01P50407	Cod. E01P50307
Satinato blu Satin blue	Cod. E01P50209	Cod. E01P50109	Cod. E01P50409	Cod. E01P50309
Satinato verde Satin green	Cod. E01P50210	Cod. E01P50110	Cod. E01P50410	Cod. E01P50310

Non adatti ad applicazioni su esterni/Not suitable for outdoor installations



Box: 01 cp/pair

POMOLI IN VETRO Ø65

GLASS KNOBS Ø 65

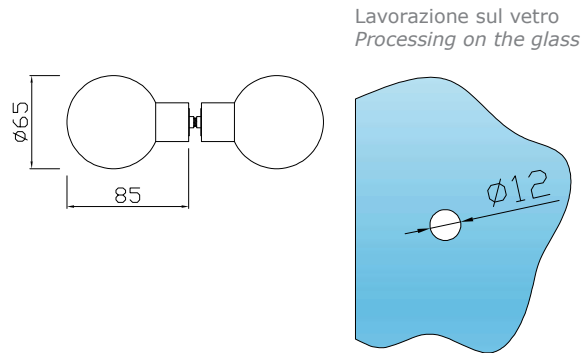

Colore vetro Glass colour	Finiture base cromo lucido Polished chrome base	Finiture base cromo satinato Satin chrome base	Finiture base oro lucido Polished gold base	Finiture base oro satinato Satin gold base
Trasparente/Transparent	Cod. E01P65201	Cod. E01P65101	Cod. E01P65401	Cod. E01P65301
Satinato bianco Satin white	Cod. E01P65206	Cod. E01P65106	Cod. E01P65406	Cod. E01P65306
Trasp. con bolle Transparent with bubbles	Cod. E01P65211	Cod. E01P65111	Cod. E01P65411	Cod. E01P65311

A richiesta/On request

Colore vetro Glass colour	Finiture base cromo lucido Polished chrome base	Finiture base cromo satinato Satin chrome base	Finiture base oro lucido Polished gold base	Finiture base oro satinato Satin gold base
Rosa/Pink	Cod. E01P65202	Cod. E01P65102	Cod. E01P65402	Cod. E01P65302
Acquamarine/Acquamarine	Cod. E01P65203	Cod. E01P65103	Cod. E01P65403	Cod. E01P65303
Verde/Green	Cod. E01P65205	Cod. E01P65105	Cod. E01P65405	Cod. E01P65305
Blu/Blue	Cod. E01P65204	Cod. E01P65104	Cod. E01P65404	Cod.e E01P65304
Satinato acquamarine Satin aquamarine	Cod. E01P65208	Cod. E01P65108	Cod. E01P65408	Cod. E01P65308
Satinato rosa Satin pink	Cod. E01P65207	Cod. E01P65107	Cod. E01P65407	Cod. E01P65307
Satinato blu Satin blue	Cod. E01P65209	Cod. E01P65109	Cod. E01P65409	Cod. E01P65309
Satinato verde Satin green	Cod. E01P65210	Cod.e E01P65110	Cod. E01P65410	Cod. E01P65310

Non adatti ad applicazioni su esterni/Not suitable for outdoor installations

Pomoli Knobs



Box: 10 pz/pcs

POMOLI IN VETRO AD INCOLLAGGIO UV UV GLUING GLASS KNOBS

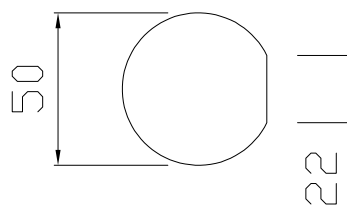

Codice/Code	Ø	Finiture/Finishes
A12P50001	50 mm	trasparente/transparent
A12P50002	50 mm	satinato bianco/satin white



Box: 50 pz/pcs

POMELLI A PALLA Ottone SPHERICAL KNOBS Brass

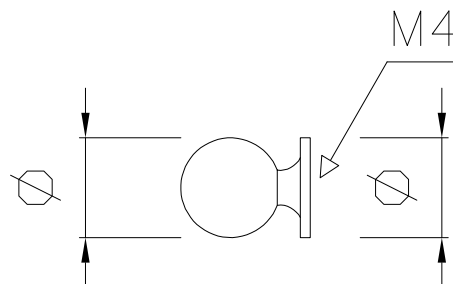

Codice/Code	Ø	Finiture/Finishes
A08M02002	20 mm	cromo lucido/polished chrome
A08M01003	20 mm	cromo satinato/satin chrome
A08M04004	20 mm	oro lucido/polished gold
A08M03005	20 mm	oro satinato/satin gold
A08M05001	20 mm	bronzato/bronze
A08M02012	30 mm	cromo lucido/polished chrome
A08M01013	30 mm	cromo satinato/satin chrome
A08M04014	30 mm	oro lucido/polished gold



Box: 01 pz/pcs

POMOLI IN VETRO Ø 20 MM

Base in ottone cromato lucido

GLASS KNOBS Ø 20 MM

Base in brass polished chrome finish

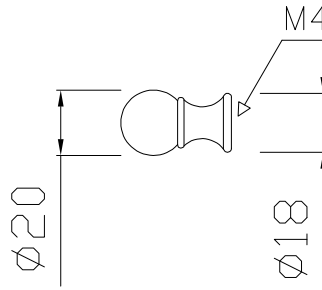

Codice/Code	Colori vetro/Glass colours
A08P02011	Satinato/Satin
A08P02013	Trasparente/Transparent

A richiesta/On request

Codice/Code	Colori vetro/Glass colours
A08P02001	Acqua mare/Aquamarine
A08P02003	Blu/Blue
A08P02005	Rosa/Pink
A08P02007	Satinato acqua mare/Satin aquamarine
A08P02009	Satinato rosa/Satin pink
A08P02015	Verde/Green
A08P02017	Verde chiaro/Pale green



Box: 01 pz/pcs

POMOLI IN VETRO Ø 25 MM

Base in ottone

GLASS KNOBS Ø 25 MM

Base in brass

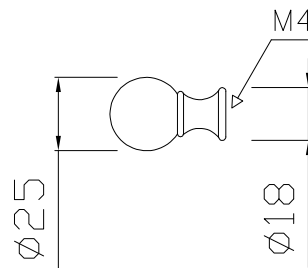

Colore vetro Glass colour	Finiture base cromo lucido Polished chrome based	Finiture base oro lucido Polished gold based
Trasparente/Transparent	Codice/Code A08P02026	Codice/Code A08P04025

Trasp. con bolle
Transparent with bubbles

Codice/Code A08P02019 Codice/Code A08P04020